

# TR20S Tuffrail® Stainless Steel Industrial Handrail Specifications

## Top & Midrail For level, rake or stair applications

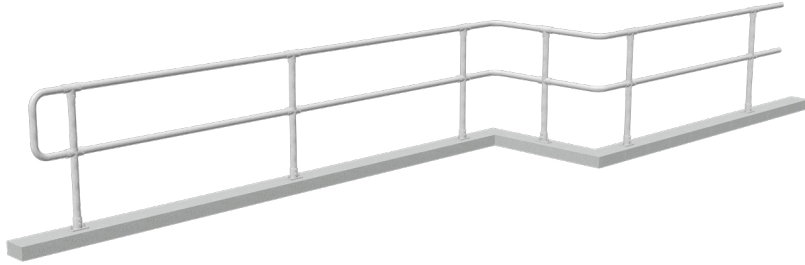

### Key features

- > Modular flexibility
- > No-weld assembly
- > Superior corrosion protection
- > Flat pack delivery
- > Colour options available
- > Available ex-stock
- > BIM & CAD Support

### Applications suited to

- > Water treatment facilities
  - > Harsh coastal environments
  - > Jetties and boardwalks
  - > Service platforms and mezzanines
  - > Warehouses and loading bays
  - > Retaining walls and culverts
  - > Roof service areas and fall edges
- Refer to applicable Aust Standards and Building Codes

### Specification Summary

Supply and install the proprietary TR20S handrail system to substrate according to Moddex specifications, or by a Moddex accredited installer.

### Technical Data

#### Material

<b>Stanchions &amp; rails</b>	316 Stainless Steel
<b>Clamp fittings</b>	Cast 316 Stainless Steel
<b>Clamp locking screws</b>	Stainless Steel (304)

#### Protective coating

<b>Optional</b>	Powder coating and paint specs*
-----------------	---------------------------------

\*The standard process for Powder Coated and Painted handrail products is as follows: black steel is used for fabrication. The steel is sand blasted and a zinc primer coating is applied. The powder coat / paint coat is then applied over the zinc primer creating a dual shield coating with a decorative finish.

### Dimensions

Variable depending on building/application/ code

#### Stanchions

<b>Diameter</b>	48.3mm OD
<b>Nominal Thickness</b>	2.77 - 3.68 mm (loading dependent)

#### Rails

<b>Diameter</b>	48.3mm OD
<b>Nominal Thickness</b>	2.77mm

#### Clamp fittings

<b>Thickness</b>	5.0mm (approx)
<b>Locking screws</b>	M12 x 1.75 x 11mm - DEXX® Drive

### Weight

Variable depending on building/application/ code

<b>Stanchion with clamps</b>	5.5 to 6.5kg
<b>Rail per metre</b>	3.11kg

### Fixings

Stanchion attachment to

<b>Concrete</b>	M12, 316 stainless chemical anchor
<b>Structural steel</b>	M16 stainless high tensile bolt set

### Compliance

Moddex TR20S handrails are designed and manufactured in accordance with Australian Standard AS:2018 and relevant statutory WHS Codes of Practice/Guidelines.

### Testing

The system has been tested by a NATA accredited laboratory to AS 1657:2018.

### Warranty

5 years from date of purchase subject to correct installation, use and maintenance in accordance with manufacturer's specifications and recommendations, unless otherwise negotiated at the time of purchase.

— Refer maintenance manual

### Inspection & Maintenance

Visual inspection for any damage or loose fixings must be done periodically and prior to use. No certified maintenance required. Basic wear and tear preventative maintenance is recommended, as per manufacturer's specifications and recommendations.

— Refer maintenance manual

## Technical Information

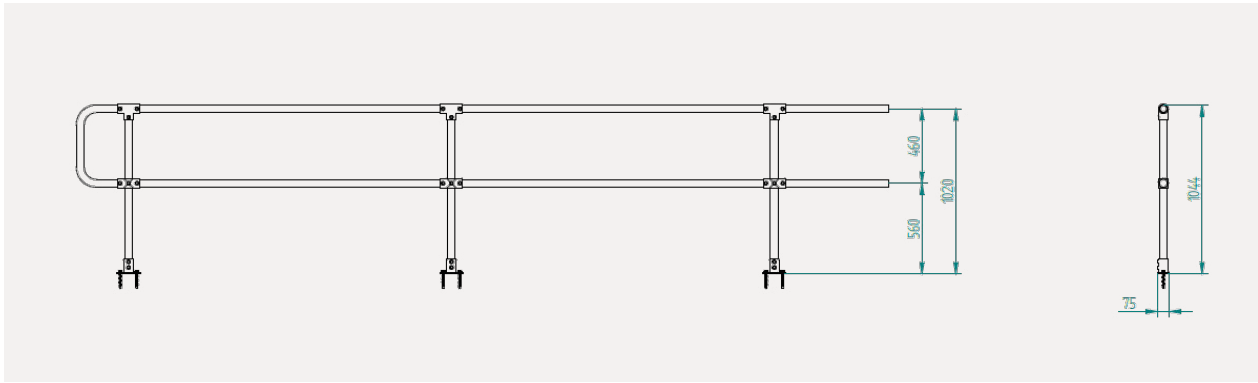

## Mount Dimensions

T2 - Top Mount (2 Fixings)	GD - Inground Mount	CD - Cored Mount
<p>Diagram showing a post mounted on a base. The base has a width of 102 units and a height of 75 units.</p>	<p>Diagram showing a post mounted in a hole. The hole has a depth of 500 units.</p>	<p>Diagram showing a post mounted in a base. The base has a depth of 150 units.</p>

## Standard References

Australian Standard AS 1657:2018

- 5.4 GUARDRAILING
- 5.4.1
- 5.4.2
- 5.5 TOEBOARD

**Important Note:** Failure to supply and/or install proprietary product in accordance with above Standards and codes, specification and instructions, voids complete system certification and/or warranty.

Designed and manufactured by Moddex. ©Moddex Group. All Rights Reserved.

For information or technical support please contact us

- T 1800 663 339 (AU)
- T 0800 663 339 (NZ)

[moddex.com](http://moddex.com)

TR20S

## Technical Drawing MD582.0600 – Self Closing Gate

<b>MD582.0600</b>	
<b>Post Spacing</b>	600mm
<b>Length</b>	460mm
<b>Height</b>	460mm

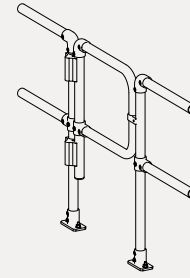
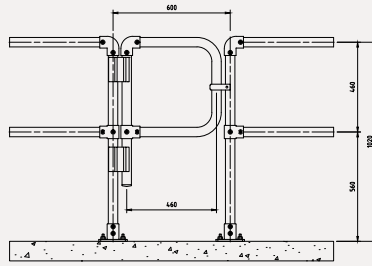

## Technical Drawing MD582.0900 – Self Closing Gate

<b>MD582.0900</b>	
<b>Post Spacing</b>	900mm
<b>Length</b>	760mm
<b>Height</b>	460mm

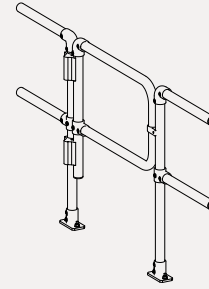
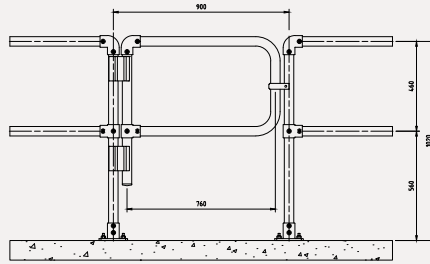

## Technical Drawing MD582.1200 – Self Closing Gate

<b>MD582.1200</b>	
<b>Post Spacing</b>	1200mm
<b>Length</b>	1060mm
<b>Height</b>	460mm

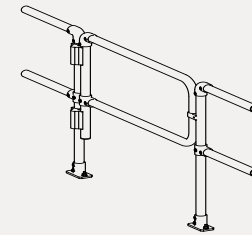
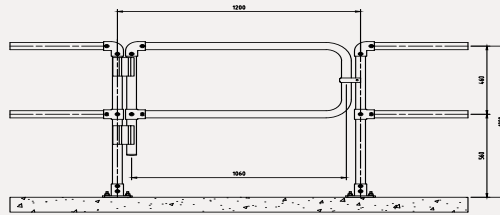

## Technical Drawing MD582.1500 – Self Closing Gate

<b>MD582.1500</b>	
<b>Post Spacing</b>	1500mm
<b>Length</b>	1360mm
<b>Height</b>	460mm

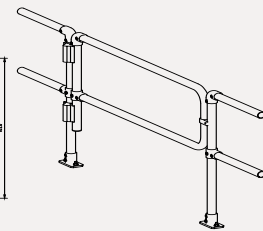
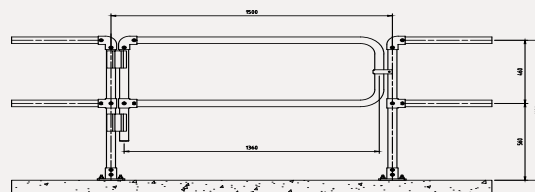

## Technical Drawing – 900mm Custom Gate with Toeboard

<b>MD582.0900 Custom</b>	
<b>Post Spacing</b>	900mm
<b>Length</b>	760mm
<b>Height</b>	1034mm

