

TR30A Tuffrail® Aluminium Industrial Handrail Specifications

Top / Mid & Bottom Rails Featuring Aluminium Connectors For level, rake or stair applications

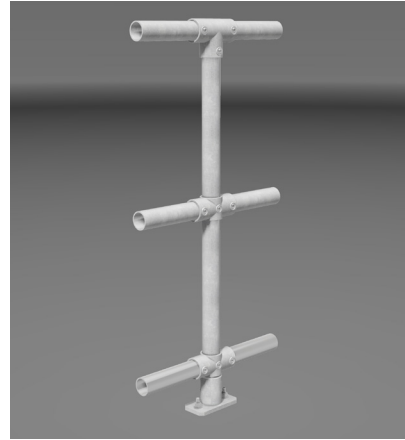

Image credit - Level Crossing Removal Authority



Key features

- > Modular flexibility
- > No-weld assembly
- > Superior corrosion protection
- > Lightweight
- > Flat pack delivery
- > Colour options available
- > Available ex-stock
- > BIM & CAD Support

Applications suited to

- > Water treatment facilities
 - > Coastal environments
 - > Jetties and boardwalks
 - > Service platforms and mezzanines
 - > Warehouses and loading bays
 - > Retaining walls and culverts
 - > Roof service areas and fall edges
- Refer to applicable Aust Standards and Building Codes

> **Note:** Not suited to chlorine rich environments

Specification Summary

Supply and install the proprietary TR30A Tuffrail Aluminium system to substrate according to Moddex specifications, or by a Moddex accredited installer.

Technical Data

Material

Stanchions & rails	Marine grade structural aluminium 6106-T6
Clamp fittings	Aluminium@ Cast Alloy
Clamp locking screws	Stainless steel (304)

Protective coating

Optional	Powder coating and paint specs*
-----------------	---------------------------------

*The standard process for Powder Coated and Painted handrail products is as follows: black steel is used for fabrication. The steel is sand blasted and a zinc primer coating is applied. The powder coat / paint coat is then applied over the zinc primer creating a dual shield coating with a decorative finish.

Dimensions

Variable depending on building/application/code

Stanchions

Diameter	48.3mm OD
Nominal Thickness	3.2 - 4.0mm (loading dependent)

Rails

Diameter	48.3mm OD
Nominal Thickness	3.2mm

Clamp fittings

Thickness	5.0mm (approx)
Locking screws	M12 x 1.75 x 11mm - DEXX® Drive

Weight

Variable depending on building/application/code

Stanchion with clamps	2.5 to 3.3kg
Rail per metre	1.6kg

Fixings

Stanchion attachment to

Concrete	M12 galvanized mechanical concrete anchor
Structural steel	M16 galvanized high tensile bolt set

*Other Fixing options are available on request

Compliance

Moddex TR30A handrails are designed and manufactured in accordance with Australian Standard AS1657:2018 and relevant statutory WHS Codes of Practice/ Guidelines.

Testing

The system has been tested by a NATA accredited laboratory to AS 1657:2018.

Warranty

5 years from date of purchase subject to correct installation, use and maintenance in accordance with manufacturer's specifications and recommendations, unless otherwise negotiated at the time of purchase.

— Refer maintenance manual

Inspection & Maintenance

Visual inspection for any damage or loose fixings must be done periodically and prior to use. No certified maintenance required. Basic wear and tear preventative maintenance is recommended, as per manufacturer's specifications and recommendations.

Note: Not suited to chlorine rich environments

— Refer maintenance manual

Technical Information

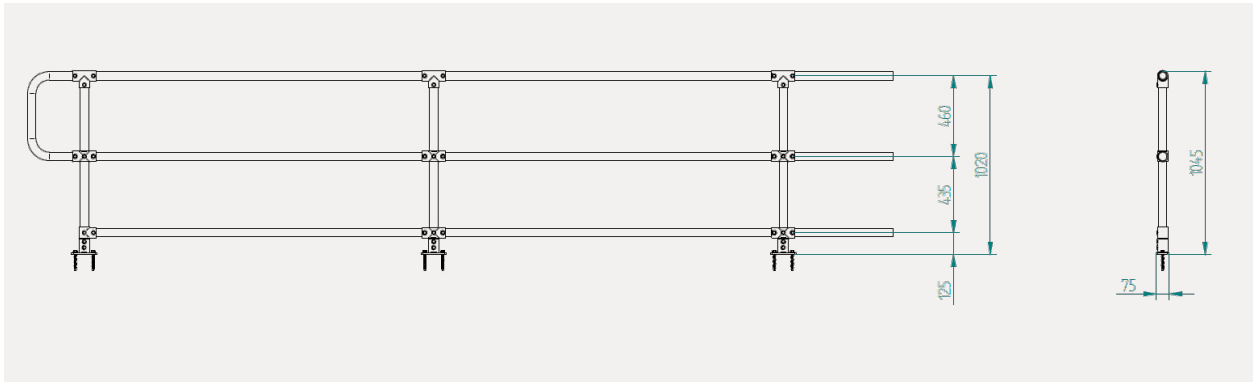

Mount Dimensions

T2 - Top Mount (2 Fixings)	F2 - Face Mount (2 Fixings)	CL - Channel Mount (2 Fixings)
GD - Inground Mount	CD - Cored Mount	AM - Angle Mount

Standard References

Australian Standard AS 1657:2018

5.4 GUARDRAILING
5.4.1
5.4.2

5.5 TOEBOARD

Important Note: Failure to supply and/or install proprietary product in accordance with above Standards and codes, specification and instructions, voids complete system certification and/or warranty.

Designed and manufactured by Moddex. ©Moddex Group. All Rights Reserved.

For information or technical support please contact us

T 1800 663 339 (AU)

T 0800 663 339 (NZ)

moddex.com

TR30A

Technical Drawing MD582.0600 - Self Closing Gate

MD582.0600	
Post Spacing	600mm
Length	460mm
Height	460mm

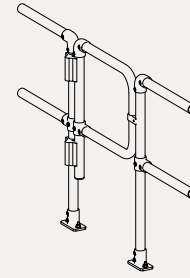
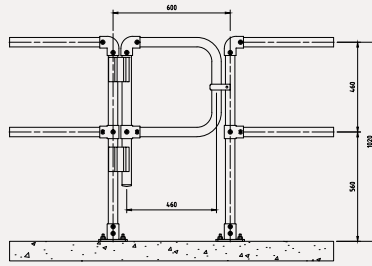

Technical Drawing MD582.0900 - Self Closing Gate

MD582.0900	
Post Spacing	900mm
Length	760mm
Height	460mm

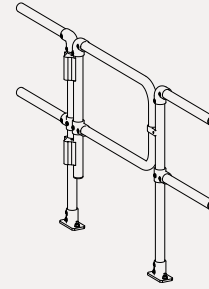
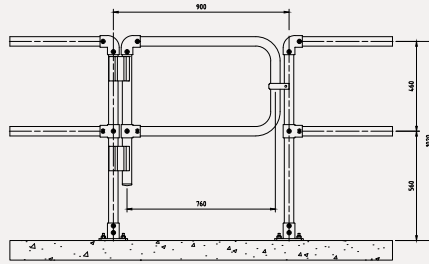

Technical Drawing MD582.1200 - Self Closing Gate

MD582.1200	
Post Spacing	1200mm
Length	1060mm
Height	460mm

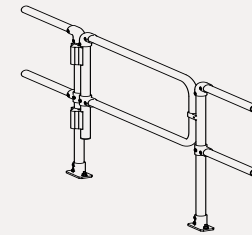
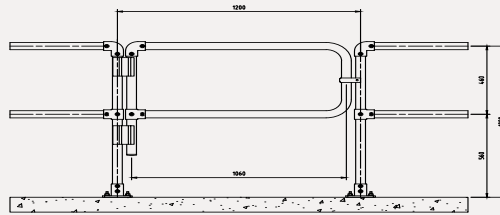

Technical Drawing MD582.1500 - Self Closing Gate

MD582.1500	
Post Spacing	1500mm
Length	1360mm
Height	460mm

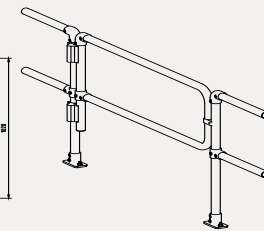
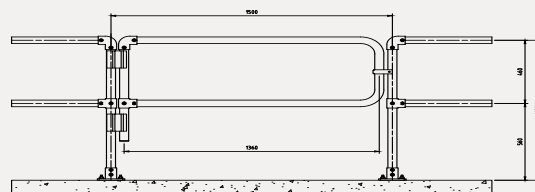

Technical Drawing - 900mm Custom Gate with Toeboard

MD582.0900 Custom	
Post Spacing	900mm
Length	760mm
Height	1034mm

