

# TR30Y Tuffrail® Safety Yellow

## Industrial Handrail Specifications

### Top / Mid & Bottom Rails

For level, rake or stair applications

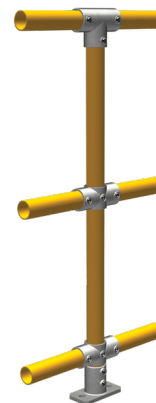
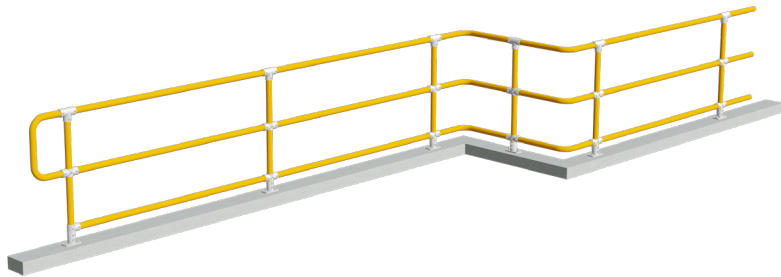

#### Key features

- > Modular flexibility
- > No-weld assembly
- > Flat pack delivery
- > Reduced corrosion
- > Colour options
- > Available ex-stock
- > BIM & CAD Support

#### Applications suited to

- > Service platforms and mezzanines
  - > Warehouses and loading bays
  - > Airports and shopping centres
  - > Retaining walls and culverts
  - > Roof service areas and fall edges
  - > Pedestrian pathways and footbridges
  - > Carparks and community centres
- Refer to applicable Aust Standards and Building Codes

#### Specification Summary

Supply and install the proprietary TR30Y handrail system to substrate according to Moddex specifications, or by a Moddex accredited installer.

#### Technical Data

##### Material

**Stanchions, rails & balustrades** Steel/grade C250 & 350

**Clamp fittings** Malleable Cast iron

**Clamp locking screws** Stainless Steel (304)

##### Protective coating

**Stanchions, rails and balustrades** G390 Hot-dip Galvanized (min 390g/m<sup>2</sup>)

**Clamp fittings** Hot-dip Galvanized with patented protective coating on threads

**Optional** Powder coating and paint specs\*

\*The standard process for Powder Coated and Painted handrail products is as follows: black steel is used for fabrication. The steel is sand blasted and a zinc primer coating is applied. The powder coat / paint coat is then applied over the zinc primer creating a dual shield coating with a decorative finish.

#### Dimensions

Variable depending on building/application/ code

##### Stanchions

<b>Diameter</b>	48.3mm OD 41.9mm ID
<b>Nominal Thickness</b>	3.2 – 4.0mm (loading dependent)

##### Rails

<b>Diameter</b>	48.3mm OD 41.9mm ID
<b>Nominal Thickness</b>	3.2mm

##### Clamp fittings

<b>Thickness</b>	5.0mm (approx)
<b>Locking screws</b>	M12 x 1.75 x 11mm - DEXX Drive

#### Weight

Variable depending on building/application/ code

<b>Stanchion with clamps</b>	7.2 to 8.0kg
<b>Rail @ 6.0m</b>	21.6kg

#### Fixings

Stanchion attachment to

<b>Concrete</b>	M12 galvanized mechanical concrete anchor
<b>Structural steel</b>	M16 galvanized high tensile bolt set

\*Other Fixing options are available on request

#### Compliance

Moddex TR30Y handrails are designed and manufactured in accordance with Australian Standard AS1657:2018 and relevant statutory WHS Codes of Practice/ Guidelines. Galvanized to AS/NZS 4680:2006 & AS1450-2007

#### Testing

Testing and performance based on requirement of Australian Standard AS1170.1 Clause 3.6 Table 3.3. Stringent vibration endurance tests have been performed and independent testing has been carried out to confirm the suitability of the Moddex system in maritime conditions. The system has been tested by a NATA accredited laboratory to AS 1657:2018.

#### Warranty

5 years from date of purchase subject to correct installation, use and maintenance in accordance with manufacturer's specifications and recommendations, unless otherwise negotiated at the time of purchase.

— Refer maintenance manual

#### Inspection & Maintenance

Visual inspection for any damage or loose fixings must be done periodically and prior to use. No certified maintenance required. Basic wear and tear preventative maintenance is recommended, as per manufacturer's specifications and recommendations.

— Refer maintenance manual

## Technical Information

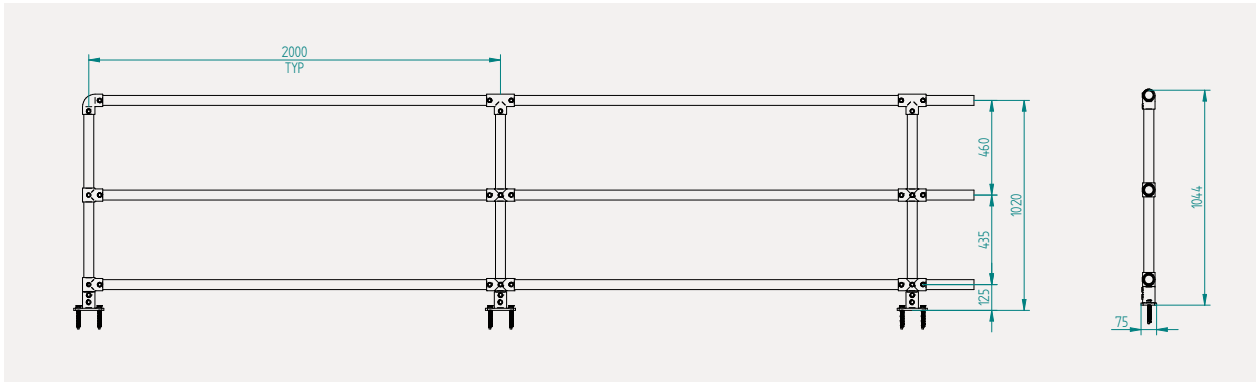

## Mount Dimensions

T2 - Top Mount (2 Fixings)	F2 - Face Mount (2 Fixings)	CL - Channel Mount (2 Fixings)
GD - Inground Mount	CD - Cored Mount	AM - Angle Mount

## Standard References

Australian Standard AS 1657:2018

3.2.1.2  
3.4.3

5.4 GUARDRAILING

5.4.1  
5.4.2

5.5 TOEBOARD

**Important Note:** Failure to supply and/or install proprietary product in accordance with above Standards and codes, specification and instructions, voids complete system certification and/or warranty.

Designed and manufactured by Moddex. ©Moddex Group. All Rights Reserved.

For information or technical support please contact us

T 1800 663 339 (AU)

T 0800 663 339 (NZ)

[moddex.com.au](http://moddex.com.au) | [moddex.co.nz](http://moddex.co.nz)

TR30Y

## Technical Drawing MD582.0600 - Self Closing Gate

MD582.0600	
Post Spacing	600mm
Length	460mm
Height	460mm

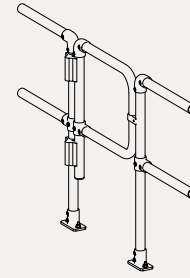
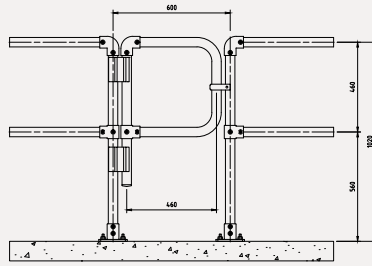

## Technical Drawing MD582.0900 - Self Closing Gate

MD582.0900	
Post Spacing	900mm
Length	760mm
Height	460mm

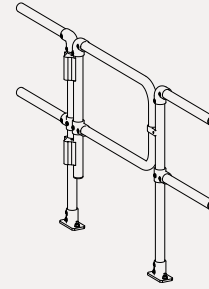
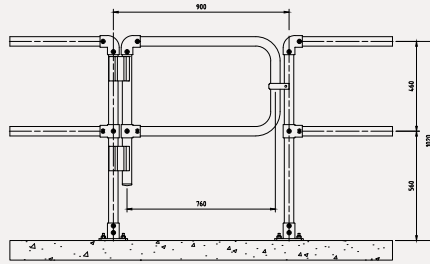

## Technical Drawing MD582.1200 - Self Closing Gate

MD582.1200	
Post Spacing	1200mm
Length	1060mm
Height	460mm

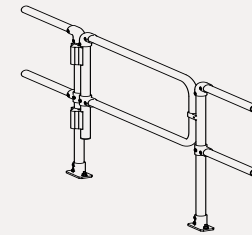
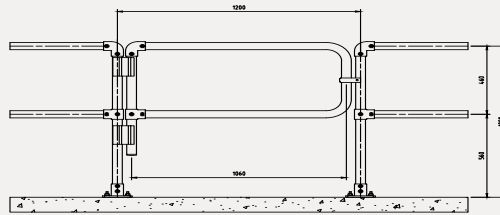

## Technical Drawing MD582.1500 - Self Closing Gate

MD582.1500	
Post Spacing	1500mm
Length	1360mm
Height	460mm

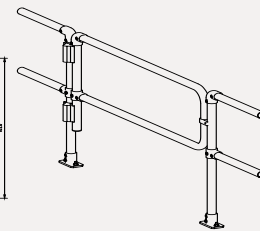
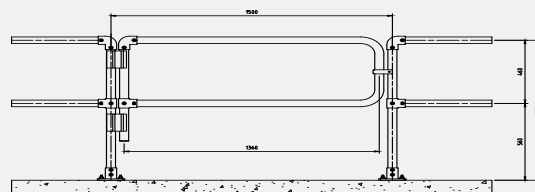

## Technical Drawing - 900mm Custom Gate with Toeboard

MD582.0900	Custom
Post Spacing	900mm
Length	760mm
Height	1034mm

