

Balustrade / Single Inline Handrail

For level and stair applications above one metre

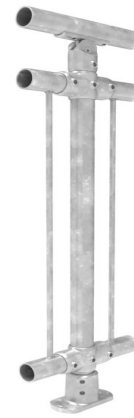
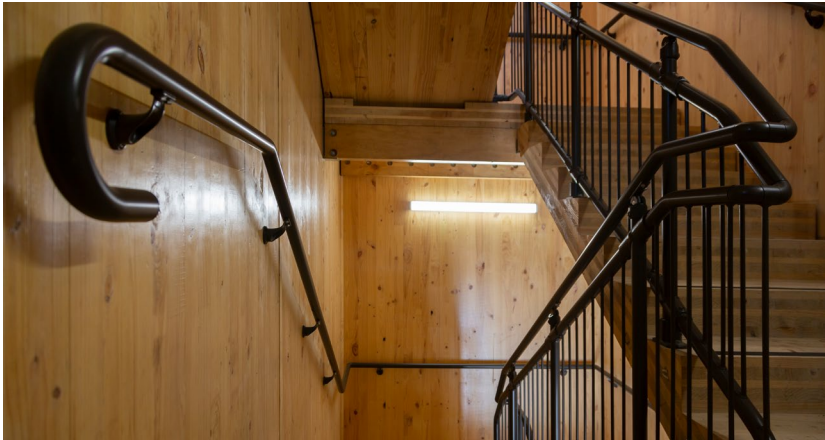

Key features

- > Modular flexibility
- > No-weld assembly
- > Flat pack delivery
- > Reduced corrosion
- > Colour options
- > Available ex-stock
- > BIM & CAD Support

Applications suited to

- > Retaining walls and carparks
- > Access ramps and stairs
- > Accommodation units
- > Sporting facilities and stadiums
- > Public transport and sightseeing
- > Fire and access stairs
- > Footbridges and culverts
- > Loading bays and mezzanines
- > Refer to applicable NZ Standards and Building Codes.

Specification Summary

Supply and install the proprietary CB30 barrier system to substrate according to Moddex specifications, or by a Moddex accredited installer.

Technical Data

Material

Stanchions, rails & balustrades	Steel/grade C250 & 350
Clamp fittings	Malleable Cast iron
Clamp locking screws	Stainless Steel (304)

Protective coating

Stanchions, rails and balustrades	G390 Hot-dip Galvanize (min 390g/m ²)
Clamp fittings	Hot-dip Galvanized with patented protective coating on threads
Optional	Powder coating and paint specs*

*The standard process for Powder Coated and Painted handrail products is as follows: black steel is used for fabrication and then hot-dipped galvanized. Product is then de-gassed and pre-treated before powder coating is applied on top of galvanising.

Dimensions

Variable depending on building/application/ code

Stanchions

Diameter	48.3mm OD 41.9mm ID
Nominal Thickness	3.2mm - 4.0mm (loading dependent)

Rails

Diameter	48.3mm OD 41.9mm ID
Nominal Thickness	3.2mm

Balustrade

Baluster	12mm
Baluster Centres	100mm (88mm gap)
Heavy Duty Baluster	16mm
Baluster Centres	100mm (86mm gap)

Custom Baluster spacings available on request to suit School Facility Standards (SFS)

Clamp fittings

Thickness	5.0mm (approx)
Locking screws	M12 x 1.75 x 11mm - DEXX [®] Drive

Weight

Variable depending on building/application/ code

Stanchion with clamps	7.2 to 8.0kg
Rail @ 6.0m	21.6kg
Balustrade Panel @ 2.0m	29kg

Fixings

Stanchion attachment to

Concrete	M12 galvanized mechanical concrete anchor
Structural steel	M16 galvanized high tensile bolt set

Fixings cont.

Timber	Stainless or galv coach screws
*Other Fixing options are available on request	

Compliance

Moddex CB30 balustrades are designed and manufactured in accordance with the New Zealand Building Code D1 Access Routes and F4 Safety from Falling. Galvanized to AS 4792 and AS/NZS 4680:2006 (where applicable).

Testing

Testing and performance based on requirement of Standard AS/NZS 1170.1 Clause 3.6 Table 3.3. Static load testing has been performed and independent testing has been carried out to confirm the suitability of the Moddex system in maritime conditions.

Warranty

5 years from date of purchase subject to correct installation, use and maintenance in accordance with manufacturer's specifications and recommendations, unless otherwise negotiated at the time of purchase.

Basis of Design

When designed as per the Moddex PS1

1. Design Life: 50 years minimum
2. Building Occupancy: A, B/E & C3
3. Loadings: AS/NZS 1170.1:2002 - Table 3.3 AS 1657:2013 - CL6.1
4. Live Loadings: Line: 0.75 kN/m
Concentrated: 0.6 kN
Infill: 1kPa/0.5kN

BPIR

BPIR, set new minimum requirements for the level of information required about building products supplied to the New Zealand market. Moddex is committed to meeting these requirements - download the latest information here:

<https://moddex.com/resources/downloads/#bpir-sheets>

Technical Information

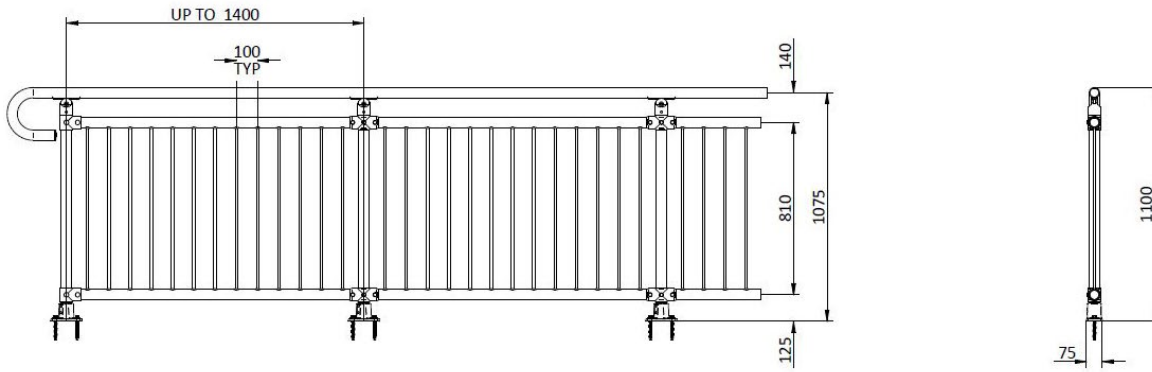

Mount Dimensions

FIXING TO CONCRETE

T2 - Top Mount (2 Fixings)

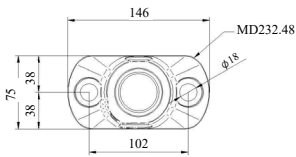

F2 - Face Mount (2 Fixings)

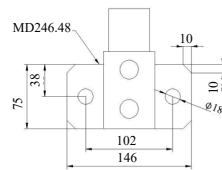

CD - Cored Mount

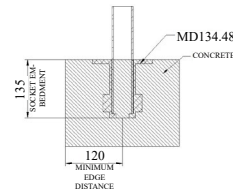

T4 - Top Mount (4 Fixings)

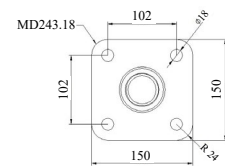

FIXING TO STEEL

T2 - Top Mount (2 Fixings)

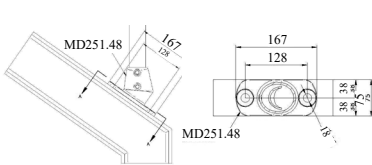

F2 - Face Mount (2 Fixings)

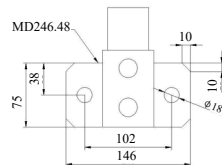

T4 - Top Mount (4 Fixings)

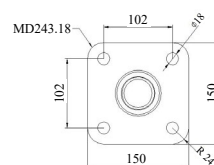

FIXING TO TIMBER

T4 - Top Mount (4 Fixings)

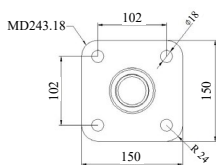

F4 - Face Mount (4 Fixings)

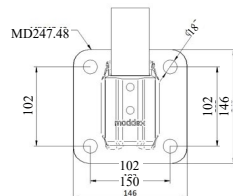

Standard References

New Zealand Building Code

- As noted in NZBC Clause D1 Access Routes, handrails shall be provided on both sides of accessible stairways and accessible ramps.
- When a ramp, stair or landing is situated so that a person could fall 1m or more, then a barrier shall be provided that meets the requirements of NZBC Clause F4 Safety from falling.

[DOWNLOAD OUR GUIDE TO HANDRAIL & BALUSTRADE COMPLIANCE HERE](#)

Important Note: Failure to supply and/or install proprietary product in accordance with above Standards and codes and the Moddex PS1, voids complete system certification and/or warranty.

Designed and manufactured by Moddex. ©Moddex Group. All Rights Reserved.

For information or technical support please contact us

T 1800 663 339 (AU)
T 0800 663 339 (NZ)

moddex.com

CB30